

BAR
— IN PROGRESS



**ONEMORE
BARTOOL**





ALWAYS FORWARD

Crediamo che un professionista debba essere sempre in movimento, senza spazio e senza tempo, che cerchi la qualità, che voglia essere sempre aggiornato e che abbia un suo stile. Bar in Progress fa di questo la sua filosofia. Per questo collabora ogni giorno con i migliori Bartender del mondo. Costantemente studiamo, progettiamo, ricerchiamo e selezioniamo accessori che diano soddisfazione a ogni professionista.

La ricerca della qualità, l'osservazione dei mercati, delle tendenze e delle nuove tecniche di miscelazione portano alla nascita di nuovi prodotti all'avanguardia. I nostri accessori spaziano dal settore del Catering e dell'allestimento specializzato per Cocktail Bar, alle Bag multi accessoriate per il Bartender professionista, a tutti gli oggetti piccoli e grandi con cui miscelare cocktail e organizzare la postazione.

We believe that a professional should be always in motion, without space and without time, he must seek quality, he must always be up to date and with his own style. Bar in Progress has made this its philosophy. This is why we collaborate every day with the world's best Bartenders.

Constantly studying, researching, planning and selecting accessories that gratify every professional.

Our search for quality, our observation of the market, our study of trends and new blending techniques leads to the birth of cutting edge products. Our accessories range from the Catering industry and the specialized Cocktail Bar, professional Bartender multi equipped Bag's, to all small and big objects used to mix cocktails and organize the bar station.

BAR STATION & CATERING

Postazioni cocktail pronte all'uso e trasportabili, utilizzabili ovunque per una perfetta organizzazione, materiali in ABS

Made in Italy. *Cocktails Station, ready to use everywhere for a perfect organization, Made in Italy ABS materials.*



DESIGNED by
Bar in Progress

TIKI001 TIKI BAR

Postazione in bamboo
Bamboo Bar Station

Il Tiki è una divinità polinesiana che viene rappresentata con facce incise e dipinte su pietra. DON BEACH aprì a Hollywood nel 1930 un bar specializzato in cocktail esotici e fu subito tendenza. Euforia, spensieratezza, sorrisi e voglia di sognare: da qui nasce il Tiki Bar.

DESIGNED by
Bar in Progress

TIKI BAR

Altezza Mt. 2,45
Larghezza Mt. 1,63
Profondità Mt. 0,92
MATERIALE
Bamboo (ecosostenibile)





**SET UP
KIT CATERING**

Lavello,
rubinetto acqua,
impianto pompa elettrica carico acqua,
taniche carico / scarico acqua 7 Lt.,
trasformatore 12 vv,
interruttore a pedale.

KIT COCKTAIL

Vasca Abs, 7 portafrutti.
Capacità 30 kg.

PIANO STOCCAGGIO

Rialzato da terra, come da normativa.
Predisposizione passaggio cavi
tubazioni.



**BACK BAR
CARATTERISTICHE**

Piano neutro per stoccaggio / area di lavoro.
Piano rialzato stoccaggio / poggia
Liquor Display.
Vano neutro stoccaggio / frigo.
2 Piani neutri per stoccaggio.
Piano rialzato terra per stoccaggio,
come da normativa.



**BACK BAR
CARATTERISTICHE**

Altezza Mt.1,20
Larghezza Mt. 1,63
Profondità Mt. 0,92



MODC001
SUPER COMPACT
Modulo Cocktail Station Inox
Aisi304 18/10 – 150*70*83h cm

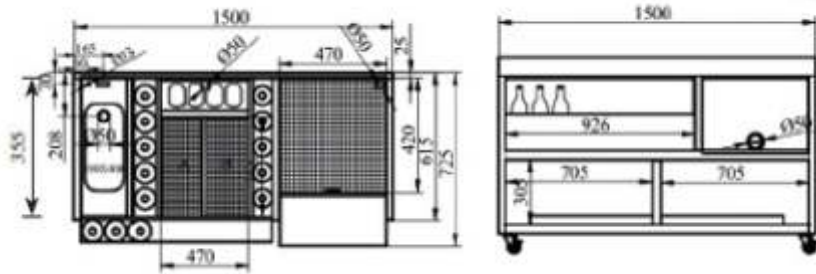

MODG001
GLASSWARE COMPACT
Modulo Cocktail Station Inox
Aisi304 18/10 – 125*70*83h cm

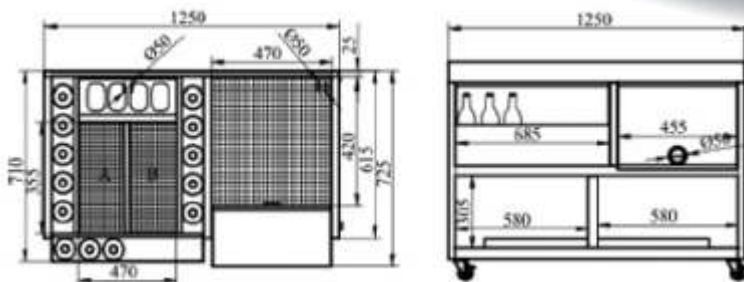

MODS001
SINK COMPACT
Modulo Cocktail Station Inox
Aisi304 18/10 – 100*70*83h cm

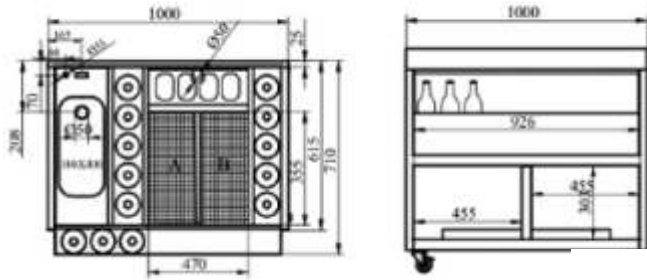

MODI001
COMPACT
Modulo Cocktail Station Inox
Aisi304 18/10 – 75*70*83h cm

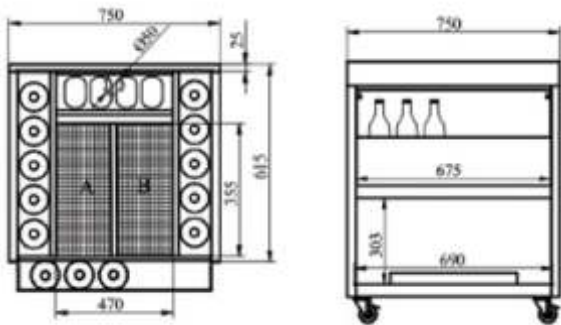

DESIGNED by
Bar Progress

CCST001

COCKTAIL CATERING STATION

In plastica ABS antiurto

Postazione completa 130 cm

Leggera e resistente con telaio in acciaio e piani in ABS anti urto, è realizzata con materiale ignifugo e certificazione di idoneità sanitaria. Si compone di un piano carrello montato su ruote per facilitarne gli spostamenti e un piano di lavoro e di appoggio dove si inserisce una capiente vasca ad incasso con una capienza di oltre 15 kg di ghiaccio.



*Lightweight and durable station with steel frame and ABS shelf and tops.
It's a trolley mounted on wheels to allow movements and organization of work where is inserted a large bathtub with a capacity of over 15 kg of ice.*

Components

- 1 built-in Module station
- 7 condiment holder removable.
- 2 juice bottles separators.
- 1 ice cube and crushed cube separator .
- 1 ice separator - draining water.
- 1 drain with gasket
- 1 PVC panel customizable with own brand
- 1 speed rack abs 85 cm (10 bottles)
- 1 speed abs rack for blender
- 1 abs top service bar.
- 1 abs work top shelf.
- 1 stock shelf with hole for water / electricity connection.
- 4 directional wheels (2 with brake)



**PERSONALIZZABILE
CON IL VOSTRO LOGO**

Front panel fully customizable



**LEGGERA E FACILE
DA TRASPORTARE.**

Light and easy to carry!



DESIGNED by
BarProgress

BORC001
COCKTAIL CATERING BAG
Borsone per Cocktail Catering Station (optional)
41 X 72 X H 85 CM



DESIGNED by
BarProgress

BORV001
BUILT-IN BAG
Borsone per vasca built-in module (optional)

FACILE DA MONTARE

Easy to set!

- A** Modulo smontato
Disassembled module
- B** Struttura con telaio in acciaio
Steel-framed structure
- C** Completa di vasca Compact Station
da incasso e 2 nuovi Speed rack in ABS
*Complete with the new built-in cocktail station
and 2 new ABS speed rack*

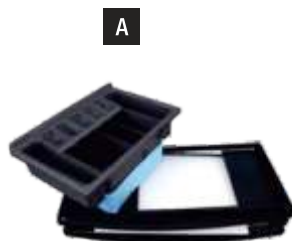

DESIGNED by
BarProgress

LVLL001
SINK UNIT
Lavello per Cocktail Catering Station (optional)
Sink for Cocktail Catering Station

Sistema acqua a circuito chiuso
2 Taniche carico/scarico acqua (5 lt cad)
Pompa 12 V
Misure 41*72*85 cm

*Closed circuit water system
2 loading/ unloading tanks water (5 liters each)
12 V pump
Size 41 X 72 X H 85 CM*



Perfetta per organizzare un banco in maniera economica ed efficiente. Con una capienza di oltre 15 kg di ghiaccio tra cubi e tritato, garantisce una lunga autonomia di lavoro sia grazie alla grande quantità di ghiaccio che può contenere ed al sistema di scolo che consente all'acqua in eccesso di defluire.

Suddivisa in settori da pannelli removibili; uno più grande per separare il ghiaccio in cubetti da quello tritato e tre più piccoli dove riporre tutti i succhi di frutta e i premix che servono al lavoro.

DESIGNED by
Bar Progress

MOCI001
COMPACT STATION

Vasca cocktail da incasso in ABS antiurto, colore nero.
Built-in Module

ABS built in module, black color.

Perfect for organizing a cocktail station in an economic and efficient solution.

With a capacity of over 15 kg of cubes and crushed ice, guarantees a long working autonomy thanks to the large amount of ice that it can contain, the drainage system that allows water to flow into excess flowing out.

Divided into sectors by removable panels; a bigger one for separate the ice into cubes and three small to store all the fruit juices and premixes that are used at work.

Components

- 7 condiment holder removable.
- 2 juice bottles separator.
- 1 ice cube and crushed cube separator.
- 1 ice separator - draining water.
- 1 drain with gasket



Misure Foro
79,5 x 51 cm
Hole measures
79,5 x 51 cm

7 vaschette
con coperchio
7 condiment
holder trays

Fondo
scola ghiaccio
Drains
ice bottom



DESIGNED by
Bar Progress

SP07002 SPEED RACK small
SP10002 SPEED RACK large
BOTTLE SPEED RACKS
Tasca Portabottiglie in ABS

Misure
Small: larghezza 58cm, capienza 7 bottiglie.
Large: larghezza 85cm, capienza 10 bottiglie

Lo speed rack è una tasca portabottiglie, un accessorio utile per ottimizzare, spazi, tempi di lavoro ed organizzazione.

Da un lato elimina l'ingombro delle bottiglie che altrimenti avrebbero occupato il piano di lavoro, dall'altro gli stessi prodotti nella stessa posizione aiutano il barman a velocizzare il servizio.

La rack è in plastica rigida antiurto, flessibile, resistente e infrangibile alle collisioni con le bottiglie. Leggera e rimovibile, si può montare sia su una cocktail catering station che su un qualsiasi banco bar grazie a due semplici supporti a vite.



The speed rack is a bottle pocket, a useful accessory to optimize space, working time and barman organization. The rack is made of flexible abs plastic resistant and unbreakable to collisions with bottles. Light and removable, it can be assembled with 2 screw on a cocktail catering station or any bar counter.

DESIGNED by
Bar Progress

SPBL001
BLENDER SPEED RACKS
Portablender
in ABS nero

Lo speed rack in ABS nero antiurto è un piano per appoggiare gli strumenti elettrici come blender, mixere ice crusher. In dotazione con la cocktail catering station o acquistabile singolarmente è applicabile a qualsiasi banco bar con due viti di sostegno.



The speed rack black ABS it's a plan for support the electric tools. Supplied with the cocktail catering station or separately. Applicable to any bar station with 2 screws.

BOTTLE DISPLAYS

Gli espositori per bottiglie, sono un ottimo modo per mettere in mostra i diversi tipi di marche di spirits. Attirano l'attenzione dei clienti, creano atmosfera e senso di organizzazione del bar.

Liquor Bottle Display shelves are a great way to showcase the different types of liquor brands. It grabs the attention the guests while creating a relax ambiance and good organization of bar, efficiency, practicality and style.

Bottigliera a gradini luminosa Bottle Display with light

Maggiore visibilità prodotti Maggiore organizzazione
Materiale Lexan Basi laterali rinforzate Impianto elettrico protetto

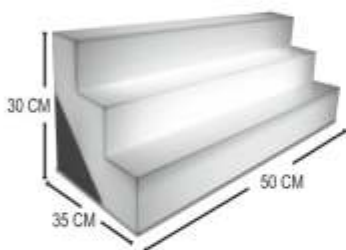

DESIGNED by
BarProgress

LIQP001 / BOTTLE DISPLAY SMALL
bottigliera a gradini luminosa 50 cm - 15 bottiglie

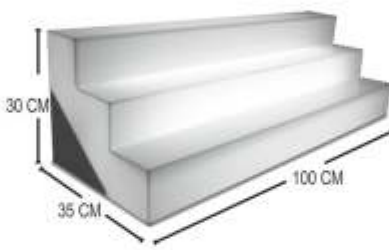

DESIGNED by
BarProgress

LIQM001 / BOTTLE DISPLAY MEDIUM
bottigliera a gradini luminosa 100 cm - 27 bottiglie



DESIGNED by
BarProgress

LIQG001 / BOTTLE DISPLAY LARGE
bottigliera a gradini luminosa 150 cm - 40 bottiglie



DESIGNED by
BarProgress

SBOT001 / BOTTLE DISPLAY SUPPORT
supporto per bottigliera con luce led bianca
100 cm

BAGS & ACCESSORIES

Borse multi accessoriate per Bartender, ideali per portare con sé tutti gli accessori con cui lavorare, abbinando efficienza, praticità e stile.

Multi-equipped bags for professional Bartenders, ideal to store and carry all the accessories to work with, combining efficiency, practicality and style.

DESIGNED by
Bar Progress

BAGS002
UTILITY BAG

borsa bartender professionale



DESIGNED by
Bar Progress

BAGS003
EXPERT BAG

borsa bartender multiaccessoriata



FONO001 / HOLSTER MINI
fondina portapenna, apribottiglie,
accendino



FON1001 / HOLSTER MEDIUM
fondina portapenna, apribottiglie,
accendino



FON2001 / HOLSTER MAXI
fondina portapenna, apribottiglie, accendino,
block notes, palmare



FON3001 / POUCH
marsupio portamonete



BORV001 / BUILTINBAG
Borsone in vasca



BORC001 / CATERING STATION BAG
Borsone telaio postazione



DESIGNED by *Bar in Progress* **BAGS001 / UTILITY BAG VINTAGE**
borsa in pelle multi accessoriata
Borsa in pelle vintage multi-accessoriata
by barinprogress®
Fully equipped vintage bag



DESIGNED by *Bar in Progress* **BAGS004 / ROLL BAG VINTAGE**
borsa bartender in vera pelle
professional leather bartender bag



DESIGNED by *Bar in Progress* **BAGS006 / TRAVEL BAG VINTAGE**
Borsa bartender in vera pelle
Bartender bag in real leather



DESIGNED by *Bar in Progress* **BAGS005 / LUX BAG VINTAGE**
Borsa bartender in vera pelle
Professional leather bartender bag



DESIGNED by *Bar in Progress* **BPAC001 / Bartender Backpack**
Zaino bartender in vera pelle.
Professional backpack real leather.



ARMS001 / ARMBAND SILVER
reggimanica, 2 pezzi per confezione,
colore argento



ARMG001 / ARMBAND GOLD
reggimanica, 2 pezzi per confezione,
colore oro



BRET001 / BRACES
bretelle colore nero, clip argento



ARML001 / ARMBAND LEATHER
Reggimanica, 2 pezzi per conf.
colore nero e pelle

DESIGNED by
Bar Progress

BAGS002

UTILITY BAG

Borsa bartender professionale

Tessuto idrorepellente, borsa dotata di cintura tracolla e maniglia. Lavabile con acqua tiepida. Ogni oggetto ha il proprio spazio, tenuto fermo da una banda elastica. Trasportabile ovunque. Efficienza e professionalità. Prodotto fatto a mano. Dimensioni: 30 x 35 x 8 cm (chiusa).

Professional bartender bag

Water repellent bag with belt, shoulder strap and handle.

Washable with warm water.

Each tools has its own space.

Size: 30 x 35 x 8 cm (closed).

Components

6 metal pour - 1 jigger - 1 citrus knife

1 polyethylene chopping board - 1 bar spoon / fork

1 speed opener - 1 strainer - 1 muddok

1 boston shaker - 1 half boston

1 squire / ice scoop - 1 ice caliper



DESIGNED by
Bar Progress

BAGS003

EXPERT BAG

Borsa bartender multi accessoriata

Borsone in tessuto idrorepellente, dotato di cinghia per il trasporto a tracolla. Prodotto fatto a mano, lavabile in acqua tiepida. Ogni oggetto ha il proprio spazio e viene tenuto fermo da una banda elastica. Ideale per il Bartender che vuole portare con sé tutti gli accessori indispensabili per il suo lavoro, in occasione di eventi e serate. Dimensioni: 73 x 24 x 24 cm (chiusa) / 73 x 96 cm (aperta).

Fully equipped bartender bag

Travel bag in waterproof fabric, equipped with shoulder strap.

Each object has its own space held by the elastic band.

Ideal for the expert bartender who wants bring all the essential accessories during events and evenings.

Size: 73 x 24 x 24 cm (closed) / 73 x 96 cm (open).

Components

1 muddler - 1 squire ice scoop - 2 speed bottle

1 bar caddy - 1 jigger - 1 bar spoon

1 strainer - 1 speed opener - 1 barmat

1 boston 28 oz- 1 half boston 16oz - 1 lime squeezer

1 ice tong - 1 cutting board - 1 citrus knife

- 8 metal pour



DESIGNED by
Bar Progress

BAGS001

UTILITY BAG VINTAGE

Borsa in pelle vintage multi-accessoriata
by barinprogress®

L'evoluzione Vintage della classica Utility Bag
Realizzata a mano in ecopelle idrorepellente
testa di moro ed interni in tessuto vintage
lavabile. Dotata di tracolla e completa delle attrezzature
indispensabili per il bartender.
L'efficienza completata dal tocco classico dello
stile vintage.
Dimensioni 30x35x8cm (chiusa)

Fully equipped vintage bag

*The Vintage evolution of the classic Utility Bag.
Handmade in eco-leather dark brown .
Interior washable in vintage cotton fabric.
Equipped with shoulder strap and complete equipment
indispensable for the bartender.
The efficiency completed by the classic touch of the
vintage style.
Size 30x35x8cm (closed)*

Components

- 6 Metal Pour
- 1 Japanese Jigger
- 1 Bar spoon
- 1 speed opener
- 1 Strainer
- 1 Muddler
- 28 oz. Boston
- 16 oz. Boston
- 1 Drain ice scoop
- 1 Lime squeezer
- 1 Cutting board
- 1 Ice tong
- 1 Citrus knife



DESIGNED by
Bar Progress

BAGS004

ROLL BAG VINTAGE

VERA PELLE

Aggiungi un tocco di classe ai tuoi preziosi strumenti di lavoro!
La Vintage Roll bag è un prodotto artigianale,
fatto interamente a mano dai maestri del cuoio.
Una la borsa professionale dedicata a professionisti
ed appassionati del settore che vogliono organizzare
i propri spazi e muoversi con stile!
Size 45*23 cm (close) 65*45cm (open)

- 8 tasche per tools di diverse dimensioni.
- 2 elastici.
- 1 astuccio con cerniera per almeno 2 shaker o mixing glass .

PREMIUM ROLL BAG

Genuine leather

*Add a touch of class to your precious work tools!
The Vintage Roll bag is a handmade product,
made entirely by hand by the masters of leather.
A professional bag dedicated to professionals
and industry enthusiasts who want to organize
your own spaces and move with style!*

Size 45 * 23 cm (close) 65 * 45cm (open)

- 8 pockets for tools of different sizes.
- 2 elastic bands.
- 1 zippered case for at least 2 shakers or mixing glass.



DESIGNED by
Bar Progress

BAGS005

LUX BAG VINTAGE

Borsa bartender in vera pelle.
Un inconfondibile stile vintage pensato per professionisti del settore che amano l'eleganza la perfezione.
Realizzata completamente a mano con pellami e finiture di altissima qualità.

- Moschettoni in Ottone Vintage
- Tracolla in pelle
- Tasche e separatori per contenere mixing glass, shaker, bitter bottle e strumenti di piccole dimensioni.
- Msura 50x22x14 cm
- Block Notes
- Penna

Optional da inserire nella tasca principale.
Roll Bag Vintage

Bartender bag in real leather.

A unique vintage style for bartender who love elegance
- Completely handmade leathers and finishes of the highest quality.

- *Vintage brass hooks.*
- *Leather shoulder strap*
- *Pockets and separators for containing mixing glass, shaker, bitter bottle and tools small size.*
- *Size 50x22x14 cm*
- *Block Notes*
- *Pen*

*Optional
Vintage
Roll Bag*



DESIGNED by
Bar Progress

BAGS006

TRAVEL BAG VINTAGE

Borsa bartender in vera pelle

La più grande della linea, uno stile casual per gli amanti della praticità e della moda.
Borsa realizzata completamente a mano in vera pelle e tessuto lavabile.

- Separatori interni amovibili grazie al velcro.
- Posizionamento a scelta dei propri strumenti in base al numero ed alle dimensioni.
- Tasca contenitiva porta documenti e telefono.
- Tasca frontale con cerniera in ottone, dotata di 7 elastici porta tools e ulteriore tasca contenitiva interna.
- Interno in tessuto lavabile.
- Manici e tracolla in pelle.
- Moschettoni e finiture in Ottone Vintage
- Misure 35x30x32h

Bartender bag in real leather

The biggest of the line, a casual style for the practical bartenders and fashion lovers.
Handmade in genuine leather and washable fabric.

- *Inside removable separators for the positioning of different size tools.*
- *Storage pocket for documents and telephone.*
- *Front pocket with brass hook, 7 elastic and additional pocket for internal containment.*
- *Leather handles and shoulder strap.*
- *Hooks and finishes in Vintage Brass*
- *Size 35x30x32h*



APRONS

Grembiuli fatti mano con tessuti o pelli pregiati. Una combinazione unica tra design particolare, tecnica e comodità per chi lavora dietro il banco di lavoro.

Aprons hand-made with high quality fabrics or leathers. A combination of design that meets every need that arises in the workplace.

DESIGNED by
Bar Progress

LAPR001

grembiule in VERA pelle
grembiule professionale by barinprogress®
Bartender aprons genuine leather

Realizzato a mano in pelle di altissima qualità, Morbido e comodo da indossare.

Dotato di tasca portaoggetti frontale ed inferiore con separatori per bartools.

- Colore: testa di moro
- Misura: taglia unica
- Lunghezza al ginocchio.
- Moschettoni di chiusura in ottone vintage.
- Anello in ottone portasciugamano.

Handcrafted in leather of the highest quality, Soft and comfortable to wear.

Equipped with front and lower utility pocket with separators for bar tools.

- Color: Dark Brown
- Measure: One Size
- Knee length.
- Vintage brass hooks for easy closing.
- Brass ring vintage for towel holder



JUNA001
JUNGLE APRON
89*62cm



BIRDA001
BIRD APRON
89*62cm



SAPR001
BIRD APRON
89*62cm



GLOA001
GLOBE APRON
89*62cm



VINTA001
VINTAGE APRON
40*65cm



VINTA002
VINTAGE APRON
85*70cm

SHAKER & BOSTON

Strumenti indispensabili per la miscelazione, da linee classiche a modelli eleganti, tutti prodotti con finiture di acciaio in alta qualità.

The essential tools for mixing, classical and elegant models, all manufactured with high quality stainless steel.



BCG5001
SHAKER COBBLER GOLD
3 pezzi, 500 ml



BCO3001
SHAKER COBBLER SMALL
3 pezzi in acciaio, 300 ml



BCO5001
SHAKER COBBLER MEDIUM
3 pezzi in acciaio, 500 ml



BCO7001
SHAKER COBBLER BIG
3 pezzi in acciaio, 700 ml



SYUG001
YUWAKI SHAKER GOLD
3 pezzi, oro lucido, 510 ml



SYUM001
YUWAKI SHAKER MIRROR
3 pezzi, acciaio lucido, 510 ml



SYAR001
SHAKER YARAI
glass 3 pezzi, 400 ml



PING001
PENGUIN SHAKER
3 pezzi, acciaio lucido, 350 ml



BOSO001
MIXING TIN
boston bilanciato
acciaio, 28 oz



BOSB001
HALF MIXING TIN
mezzo boston
bilanciato acciaio, 16 oz



BOSO002
MIXING TIN BLACK
boston
bilanciato nero, 28 oz



BOSO003
MIXING TIN WHITE
boston
bilanciato bianco, 28 oz



BOCT001
MIXINT TIN
Octagonal 24 oz



BOCT002
MIXINT TIN
Octagonal 17,5 oz

**SHAKER &
BOSTON**



SBOB001
SHAKER BOMBAY BLACK
3 pezzi 500 ml



SBOS001
SHAKER BOMBAY SILVER
3 pezzi 500 ml



SBOG001
SHAKER BOMBAY VINTAGE GOLD
3 pezzi 500 ml



SBOC001
SHAKER BOMBAY COPPER
3 pezzi 500 ml



BOSP002
SHAKER PARISIENNE BLACK
2 pezzi 900 ml



BOSP001
SHAKER PARISIENNE
SILVER MAT
2 pezzi 650 ml



BOPG001
SHAKER PARISIENNE GOLD
2 pezzi 650 ml



BOSP003
SHAKER PARISIENNE COPPER
2 pezzi 550 ml



SALL001
Shaker all in one
Inox lucido 1000 ml



SALD001
SHAKER ALADINO
Inox lucido 1300 ml



BOTS001
BOTTLE SHAKER MIRROR
acciaio lucido, 750 ml



BOSP004
SHAKER PARISIENNE SLIM
2 pezzi, 750 ml

JIGGERS

Una vasta gamma di misurini indispensabili per il dosaggio del drink, linee classiche, o design particolari per assecondare lo stile di ogni bartender.

A wide range of jigger for a perfect dosage of the drinks, classic or special designs to suit the style of each bartender.



JIBG001
BRITISH STYLE
JIGGER GOLD
dosatore con linee
di dosaggio interne
30/60 ml



JIBS001
BRITISH STYLE
JIGGER SILVER
dosatore con linee
di dosaggio interne
30/60 ml



JIBB001
BRITISH STYLE
JIGGER BLACK
dosatore con linee
di dosaggio interne
30/60 ml



JIBC001
BRITISH STYLE
JIGGER COPPER
dosatore con linee
di dosaggio interne
30/60 ml



JIBV001
BRITISH STYLE
JIGGER VINTAGE
dosatore con linee
di dosaggio interne
30/60 ml



JAES001
AERO JIGGER
Acciaio Mirror
25 ml-50 ml



JAEG001
AERO JIGGER
Acciaio Gold
25 ml-50 ml



JAEC001
AERO JIGGER
Acciaio Copper
25 ml-50 ml



JCOS001
COLEY JIGGER
Acciaio Silver
25 ml-50 ml



JCOG002
COLEY JIGGER
Acciaio Gold
25 ml-50 ml



JCOC003
COLEY JIGGER
Acciaio Copper
25 ml-50 ml



JMSB001
MR SLIM JIGGER LARGE
dosatore
60 ml/90 ml



JMSS001
MR SLIM JIGGER SMALL
dosatore
30 ml/45 ml



JYUG001
YUWAKI JIGGER GOLD
dosatore
30 ml/45 ml



JYUM001
YUWAKI JIGGER MIRROR
dosatore
30/45 ml

JIGGERS



JIGG001
JAPANESE STYLE
JIGGER LUX GOLD
dosatore, 1/2 oz



JIGG002
JAPANESE STYLE
JIGGER LUX SILVER
dosatore, 1/2 oz



JIGJ001
JAPANESE STYLE
JIGGER SMALL
dosatore economy, 15/30 ml



JIGJ002
JAPANESE STYLE
JIGGER MEDIUM
dosatore economy, 25/50 ml



JIGJ003
JAPANESE STYLE
JIGGER MEDIUM
dosatore economy, 30/60 ml



JSLV001
SLIM VINTAGE JIGGER
dosatore
H 14, 20/25/30 ml



JSRM001
SLIM RINGS MIRROR
dosatore
H 14, 20/25/30 ml



JSRF001
SLIM RINGS FROSTED
dosatore
H 14, 20/25/30 ml



JSLF001
SLIM FROSTED JIGGER
dosatore
H 14, 20/25/30 ml



JIGP001
PLASTIC JIGGER
dosatore
H 14, 20/25/30 ml



JHAM001
HAMMER JIGGER
25ML - 50 ML



YUKI001
JIGGER U STYLE SMALL
dosatore economy, 15/35 ml



YUKI002
JIGGER U STYLE LARGE
dosatore economy, 30/60 ml



JIGC001
JIGGER CLASSIC 20/40 ml



JIGM001
MULTI LEVEL JIGGER
dosatore con 5 linee di dosaggio
0,5 - 2,5 oz

STRAINERS

Da sempre un elemento fondamentale per la miscelazione, una vasta gamma di modelli che si adattano a qualsiasi forma di shaker o mixing glass.

Strainer have ben always a stable element for mixing, a wide range of models, with or without handle, classic or design for any shaker or mixing glass.



STVB001
STRAINER HAWTHORNE
LUX VINTAGE BLACK



STVC001
STRAINER HAWTHORNE
LUX COPPER



STVS001
STRAINER HAWTHORNE
LUX VINTAGE SILVER



STVG001
STRAINER HAWTHORNE
LUX VINTAGE GOLD



STRA001
STRAINER LARGE 4PRONG
colino grande con manico



STRP001
STRAINER SMALL 2PRONG
colino grande con manico



STRG001
STRAINER BARON STYLE GOLD
colino in acciaio, colore oro



STRC001
STRAINER HAWTHORNE
CLASSIC INOX 2 PRONG



STRK001
Kalaka Skull Strainer
colino in acciaio



STR001
STRAINER FULL RING SPIRAL
colino in acciaio, a spirale



STRN001
STRAINER NO PRONG
colino in acciaio, senza manico



SMTR002
STRAINER TRIANGLE
MIRROR
colino acciaio
per mixing glass

STRAINERS



JUEE002
JULEP STRAINER LUX
acciaio inox



JUEE001
JULEP STRAINER
classico in acciaio



SMTR001
STRAINER TRIANGLE
WITH HANDLE
colino con manico



STRL001
JULEP GOLD LEAF
colino foglia colore oro



SBXS001
Biloxi Fine Strainer
Silver 60 mm



SBXC001
Biloxi Strainer
Copper 60 mm

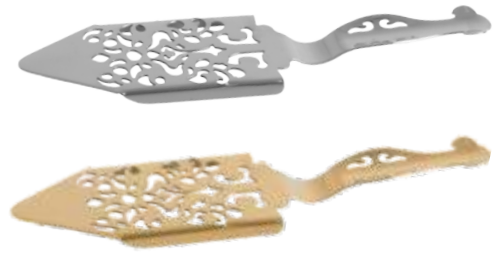

ABSINTHE SPOON cucchiaio per assenzio
CASS001 SILVER colore argento
CASS002 GOLD colore oro



COLC001
Conic Strainer
Silver 77 mm



COLP001
Conic Strainer
Copper 77 mm



COLG001
Conic Strainer
Gold 77 mm



SPOON & FORK

Cucchiaini a spirale di diverse lunghezze e colori, leggeri e facili da impugnare per una perfetta miscelazione del drink.

Spiral spoons in different plating, light and easy to hold for a perfect mixing of the drink.



TFCP001 / BAR SPOON TRIDENT COPPER LUX
stile giapponese con forchettina, 30 cm



TFGV001 / BAR SPOON TRIDENT GOLD VINTAGE LUX
stile giapponese con forchettina, 30 cm



TFBL001 / BAR SPOON TRIDENT BLACK LUX
stile giapponese con forchettina, 30 cm



TFSL001 / BAR SPOON TRIDENT SILVER LUX
stile giapponese con forchettina, 30 cm



BFRK001 / BAR SPOON TRIDENT SILVER
stile giapponese con forchettina, 25 cm



TFKG001 / BAR SPOON TRIDENT FORK GOLD LUX
stile giapponese con forchettina, 45 cm



TFKS001 / BAR SPOON TRIDENT FORK SILVER LUX
stile giapponese con forchettina, 45 cm



HOFM001 / BAR SPOON HOFFMAN STYLE SILVER LUX
stile giapponese, retro a goccia piatta, 40 cm



TEAG001 / BAR SPOON TEAR DROP GOLD LUX
stile giapponese, retro a goccia piatta, 40 cm



TEAR001 / BAR SPOON TEAR DROP SILVER LUX
stile giapponese, retro a goccia piatta, 40 cm

**SPOON &
FORK**



**BASS001 / BAR SPOON
SPIRALED SILVER**
gambo a spirale e retro flat, 27 cm



**BASS002 / BAR SPOON
SPIRALED COPPER**
gambo a spirale e retro flat, 27 cm



**BASS003 / BAR SPOON
SPIRALED GUN**
gambo a spirale e retro flat, 27 cm



**BASS004 / BAR SPOON
SPIRALED GOLD**
gambo a spirale e retro flat, 27 cm



**BSAE001
AEROSPOON**
Silver 28 cm



SGAR001
Mix Glass & Garnish
Spoon



BASM001
Mix Glass & Garnish
Spoon



BASK01
BAR SPOON SKULL
HEAD SILVER
30 cm



PCUC001
PINZA MIXOLOGIST
30 cm



BASX001
MIXOLOGIST BAR SPOON
cucchiaio forato



MEAC001
SET MISURINI MIXOLOGY
in acciaio 1,5/2,5/5/15 ml



COLI001
COLINO IN ACCIAIO
24 cm

KIT BOMBAY

Kit eleganti e di altissima qualità, in acciaio inox e diverse finiture di colori.

Elegant cocktail kit, premium stainless steel in various colors finishes.



KBOB001

KIT BOMBAY BLACK

- Shaker Bombay Black 3 pezzi 500 ml
- Strainer Hawthorne Lux Vintage - Black
- British Style Black - Leopold Style
- Trident Fork Black - 30 cm - Acciaio



KBOC001

KIT BOMBAY COPPER

- Shaker Bombay Copper 3 pezzi 500 ml
- Strainer Hawthorne Lux Vintage - Copper
- British Style Copper - Leopold Style
- Trident fork Copper - 30 cm - Acciaio



KBOV001

KIT BOMBAY VINTAGE

- Shaker Bombay Vintage Gold 3 pezzi 500 ml
- Strainer Hawthorne Lux Vintage -Gold
- British Style Vintage Gold -Leopold Style
- Trident Fork Gold Vintage- 30 cm - Acciaio



KBOS001

KIT BOMBAY SILVER

- Shaker Bombay Silver 3 pezzi 500 ml
- Strainer Hawthorne Lux Vintage - Silver
- British Style Jigger Silver - Lepold style
- Trident Fork Silver - 30 cm - Acciaio

ICE TOOLS

Gli strumenti ideali per lavorare il ghiaccio dietro il banco bar, offrire un fantastico spettacolo clienti ed aggiungere valore al drink.

The ideal tools for working the ice behind the bar offering a fantastic show to the customers and adding value to the drink.



ICEP001
ICE PICK 3 POINT
punteruolo spacca ghiaccio
3 punte



ICEP002
ICE PICK 1 POINT
punteruolo spacca ghiaccio
1 punta



ICED001
ICE CARVING DECO KNIFE
Cotello giapponese con lama vintage
decorata a mano



PGH001
ICE TONG
pinza con ghiaccio



ICEK002
ICE CARVING KNIFE



ICES001
JAPANESE ICE SAW
Sega ghiaccio 420 mm



ICEM001
ICE MALLET
martelletto rompighiaccio
di legno



ICEB001
ICE BALL MOLD
stampo per sfere ghiaccio



ICEB002
ICE BALL MOLD SQUARE



ICEK001
ICE BALL MAKER 5cm

ICE SCOOP & MUDDLER

Gli strumenti necessari per qualsiasi barista professionista, consentono di servire bevande fredde senza toccare il ghiaccio e miscelare ingredienti freschi per infondere i sapori con l'alcol.

The tools necessary for any professional bartender, allow you to serve cold drinks without touching the ice and mixing fresh ingredients to infuse the flavors with alcohol.



DESIGNED by
Bar,Progress **SQUICE**
Paletta per ghiaccio
scola acqua



SC12002 / Nero / Black



SC12003 / Rosso / Red



SC12004 / Bianco / White



SC12005 / Verde / Green



SC12006 / Giallo / Yellow



DESIGNED by
Bar,Progress **MUDDOK®**
Pestello professionale ergonomico
Professional ergonomic muddler



MUDD001 / Nero / Black



MUDR001 / Rosso / Red



MUDG001 / Giallo / Yellow



MUDV001 / Verde / Green



MUDD002
SLIM MUDDLER ACCIAIO
35 cm



MUDD003
MUDDLER CLASSIC
21 cm



SDRA001/ DRAIN ICE SCOOP
paletta ghiaccio metallo

SQUICE e MUDDOK fanno parte della collezione BarInProgress, disegnati e prodotti in Italia per garantire prodotti di qualità realizzati in plastica alimentare e conforme alle normative CE.

POURER & TESTER

Strumenti professionali, essenziali per il controllo del versaggio finalizzato ad un perfetto dosaggio del drink.

Professional tools, essential for the control of the pouring and a perfect dosage of the drink.

DESIGNED by
Bar Progress

METP001
METAL POUR
versatore professionale
in acciaio
12 pezzi / pcs



DESIGNED by
Bar Progress

BIPO001
BIPOUR
versatore professionale
in policarbonato
colore nero
12 pezzi / pcs



ABFM001 /
SPEED OPENER
apribottiglie rapido
togli metal pour



POU001 / POUR COVER
tappo per versatori,
12 pezzi / pcs



PLAP001 / PLASTIC POUR
versatore in plastica,
12 pezzi / pcs
nero / black

DESIGNED by
Bar Progress

BPOU001
PERFECT POUR - CHECK
Tester per dosaggi



DESIGNED by
Bar Progress

PERP001 /
PERFECT POUR
Tester per dosaggi
completo di fiale
e imbuto



Imbuto di versaggio
Funnel pourer



Componenti Perfect Pour
Perfect Pour components

BAR MAT

Tappetini da banco per una perfetta organizzazione del piano di servizio, realizzati in gomma di alta qualità o acciaio inox. Made in Italy.

Barmats for a perfect organization of the bar top, made in high quality rubber or stainless steel. Made in Italy.



DESIGNED by *Bar in Progress* **BARM001 / BIG MAT YELLOW**
tappetino professionale da banco
70x20 cm, bordo giallo



DESIGNED by *Bar in Progress* **BARM002 / BIG MAT WHITE**
tappetino professionale da banco
70x20 cm, bordo bianco



DESIGNED by *Bar in Progress* **BARM003 / JUNIOR MAT**
tappetino professionale da banco, 60/11 cm



DESIGNED by *Bar in Progress* **DRIP003 / DRIP TRAY LUX**
acciaio inox, 70/20 cm



DESIGNED by *Bar in Progress* **DRIP002 / DRIP TRAY LUX**
acciaio inox, 60/10 cm



DRIP001 / DRIP TRAY
acciaio inox, 50/10 cm

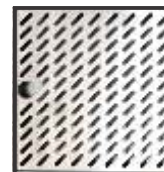

DESIGNED by *Bar in Progress* **DRIP004 / DRIP TRAY LUX**
acciaio inox, 20/20 cm

BAR SUPPLIES

Accessori indispensabili per la pulizia, l'allestimento del banco bar e l'organizzazione del servizio. *The essential bar supplies for the preparation, the cleanliness and production of the working area.*



DESIGNED by
Bar in Progress

BAR0001
BAR ORGANIZER ALL-IN
Portacannucce e tovagliolini
Bar Caddy, napkin and straw holder



CONH001
CONDIMENT HOLDER
contenitore guarnizioni



GLAR001
BAR TRAY
Vassoio rotondo, antiscivolo



STOG001
SPEED BOTTLE
LARGE
bottiglie per
succhi e premix, 2 lt



STOM001
SPEED BOTTLE
MEDIUM
bottiglie per succhi
e premix, 1 lt



STOP001
SPEED BOTTLE
SMALL
bottiglie per succhi
e premix, 1/2 lt



SQUEEZE BOTTLE
bottiglie per topping 35,4 cl
SQR001 / rossa/red
SQUG001 / gialla/yellow
SQUT001 / trasparente/trasparent



LISQ002
LIME SQUEEZER
LARGE
spremi lime-lemon
in acciaio 18/10



LISQ001
LIME SQUEEZER
zinc alloy, silver



TOVA001 / WHITE NAPKINS
tovagliolini bianchi
100 pezzi / pcs
TOVA004 / COLOURED NAPKINS
tovagliolini colorati
neri / black, rossi / red
100 pezzi / pcs



VASS001 / BAR TRAY
vassoio rotondo
antiscivolo, diam. 40,6 cm

TIKI LINE

Ampia collezione di Tiki Mug ispirate a divinità polinesiane di diverse forme e dimensioni, perfette per servire cocktail tropicali come Pina Coladas e Mai Tai che tu sia in unibeach bar o festa a tema.

Large collection of Tiki Drinkware in many different sizes and design, a great way to serve up the cocktails like Pina Colada or MaiTai, the perfect mug for any occasion or theme, whether you are an beach bar themed parties at their home.



DESIGNED by *Bar Progress*
TIKB001 / TIKINATOR ANDY
bicchiere tiki in ceramica, bianco
420 ml



DESIGNED by *Bar Progress*
TIKM001 / TIKINATOR WILLY
bicchiere tiki in ceramica, prugna
420 ml



DESIGNED by *Bar Progress*
TIKG001 / TIKINATOR TOMMY
bicchiere tiki in ceramica, giallo
420 ml



DESIGNED by *Bar Progress*
TIKC001 / TIKINATOR JOHN
bicchiere tiki in ceramica, marrone
420 ml



DESIGNED by *Bar Progress*
TCOC001 / COCONUT MUG
tazza cocco in ceramica
350 ml



TIKH001 / TIKI MUG
Holua Loa 350 ml



TIKK001 / TIKI MUG
Hua Ka'i 420 ml



TKAK001 / TIKI MUG
Aku 300 ml



TKDF001
Tiki Dragon
450 ml



TKMK001 / TIKI MUG
Monkey 550 ml



TKEL001 / TIKI MUG
Elephant 350 ml



TKMT001 / TIKI MUG
Mai Tai 430 ml



TKPI001 / TIKI
Pineapple 600 ml



TCOC002 / COCONUT MUG
565 ml



TIKV001 / TIKI
Glass 591 ml



TIKV002 / TIKI
Glass 473 ml



TIKV003 / TIKI PINEAPPLE
Glass 480 ml



TIKV004 / TIKI
Cup e Glass 414 ml

MUG & CUP

Tazze in acciaio con
finiture placcate,
perfette per rendere
costante la temperatura
del drink ed aggiungere
un tocco di classe al
drink.

Cups in steel plated finishes,
perfect for making constant
the temperature of the drink
and add a touch of class to
drink.



DESIGNED BY
Bar Progress
EMUP001
ENAMEL MUG PINEAPPLE
in metallo 385 ml.



DESIGNED BY
Bar Progress
EMUS001
ENAMEL MUG SKULLART
in metallo 385 ml.



BPIN001
PINEAPPLE CUP
Gold 710 ml



BPIN002
PINEAPPLE CUP
Gold 455 ml



JULC001
JULEP CUP
in metallo, capacità 385 ml



MCUP001
MARTINI CUP ACCIAIO
Capacità 220 ml - h. 17



MOSM001
MOSCOW MULE COPPER
color rame, interno specchiato, 16 oz

BITTER & VINTAGE BOTTLE

Una vasta gamma di bottigliette in vetro, in stile vintage o giapponese, ideali per il dosaggio di piccole quantità di prodotto come bitter o aromi.

A wide range of glass bottles, in vintage or Japanese style, ideal for the dosing small quantities of product such as bitters or essences.



DASH001
CRAQUELLE
DASH BOTTLE
with pourer
330 ml



DASH002
CUBE DASH
BOTTLE
with pourer
110 ml



DASH003
BITTER DASH
BOTTLE
with pourer
100 ml



BTMA001
BITTER SPRAY
80 ml - h.16



DATM001
DIAMOND ATOMIZER
Bottle 100 ml



ABTS001
ANTIQUE BOTTLE WHISKY
Sphere 550 MI-H20



ABTS002
ANTIQUE BOTTLE WHISKY
Sphere 250 MI-H16



ABTS003
ANTIQUE BOTTLE WHISKY
Sphere 150 MI-H14



ABTS004
ANTIQUE BOTTLE WHISKY
Sphere 50 MI-H10



ABTQ001
ANTIQUE BOTTLE WHISKY
Quadrata 400 MI-H16



ABTQ002
ANTIQUE BOTTLE WHISKY
Quadrata 250 MI-H14



ABTQ003
ANTIQUE BOTTLE WHISKY
Quadrata 150 MI-H11



ABTQ004
ANTIQUE BOTTLE WHISKY
Quadrata 50 MI-H10

MIXING GLASS

I Mixing Tin vengono utilizzati per la miscelazione di cocktail attraverso il raffreddamento con ghiaccio, strainer e spoon sono gli accessori che consentono l'utilizzo della tecnica stessa prima del versaggio tramite il beccuccio

The Mixing Tin are used for mixing cocktails through cooling with ice. The strainers and the spoons are the accessories that allow the using of technique before pouring through the spout.



DIAM001
MIXING GLASS
DIAMONDS
750 ml



JAPA001
JAPANESE MIXING GLASS
YARAI STYLE
450 ml



PADD001
MIXING GLASS
PUDDLE
550 ml



YARI001
MIXING GLASS
YARAI STYLE
450 ml



MNAP001
MIXING GLASS
NAPOLEON STYLE
1500 ml



MCUB001
MIXING GLASS
CUBANA 1000 ml



MCAL001
MIXING GLASS
CALABRESE FOOTED
3 Cuts 600 ml



MIXV001
MIXING GLASS
vetro, 474 ml



MIXG001
MIXING GLASS
WITH MARKINGS
vetro graduato, 474 ml



MIXS001
JAPANESE MIXING GLASS
Acciaio 474 ml

VINTAGE GLASSES

Collezione di bicchieri dal design vintage, ideali per aggiungere un tocco di eleganza al drink.

Collection of glasses with a vintage design, ideal to add a touch of elegance to the drink.



BHD001 / Bicchiere Longdrink Diamond 420 ml



BTD001 / Bicchiere Tumbler Diamond 365 ml



BWD001 / Bicchiere Wine Diamond 300 ml



BGV001 / Bicchiere Longdrink Vintage 310 ml



BTV001 / Bicchiere Tumbler Vintage 310 ml



BSV001 / Bicchiere Shot Vintage 92 ml



RHG001 / Retrò Highball Deco 1890 350 ml



ROLD001 / Retrò Old Fashioned Vintage Deco 1890 300 ml



RFIZZ001 / Retrò Fizz Vintage Deco 1890 350 ml



RJAR002 / RETRÒ DRINKING JAR VINTAGE
tazza in vetro con tappo vintage, foro per cannuccia, vintage hole screw



DJAR001 / DRINKING JAR 16 OZ
tazza in vetro con manico, engraved logo



RJAR001 / RETRÒ DRINKING JAR SILVER
tazza in vetro con tappo argento, foro per cannuccia, silver hole screw

BARRELL & JAR

Accessori indispensabili per
l'allestimento del banco bar e
l'organizzazione del servizio.



PBAR002 / PUNCH BARREL 5LT
Drink Dispenser vetro 5 lt



PBAR001 / PUNCH BARREL 8,5 LT
botte in vetro con rubinetto senza supporto

SBAR001 / supporto PUNCH BARREL
supporto per punch barrel 8,5 lt



BARR001 / Barrel 1 lt



STRAWS

Cannucce in acciaio, plastica o carta alimentare per essere abbinare a qualsiasi tipo di drink si voglia servire.

Straws in stainless steel, plastic or food contact paper ideal for any type of drink you want to serve.

VINTAGE STRAWS

VINC001/ VINTAGE RED STRIP
Cannucce carta 21/8 cm, 100 pcs

VINC002/ VINTAGE MIXED STRIP
Cannucce carta 21/8 cm, 100 pcs

VINC004/ VINTAGE FLOWER
Cannucce carta 21/8 cm, 100 pcs



CANM001 / METAL STRAW
cannuccia metallo, 24 cm



CLFN001 / BLACK FROZEN STRAWS
cannucce lunghe frozen cm 21/7, nere
1.000 pezzi / pcs



CALF001 / TRANSPARENT FROZEN STRAWS
cannucce lunghe frozen cm 21/7, trasparenti
1.000 pezzi / pcs



CACN001 / BLACK SHORT STRAWS
cannucce corte nere,
cm 13/7, 1.000 pezzi / pcs



CBDN001 / BIO-DEGRADABLE DRINKING STRAW BLACK, ø8x 15, 250 pcs/cf
CBDN002 / BIO-DEGRADABLE DRINKING STRAW BLACK, ø8x20, 250 pcs/cf



CBDT001 / BIO-DEGRADABLE DRINKING STRAW CLEAR, ø8x 15, 250 pcs/cf
CBDT002 / BIO-DEGRADABLE DRINKING STRAW CLEAR, ø8x 20, 250 pcs/cf

FLAIR BOTTLE

Flair Bottle da allenamento professionale.
Alta rotazione, perfetto baricentro, maneggevolissima ed indistruttibile.
Altissima performance acrobatica.

Professional training flair bottle. High rotation, perfect center of gravity, Very high acrobatic performance.

DESIGNED by
Bar Progress

XFLAIR®

Bottiglia professionale per Flair
Professional Flair bottle



FLAP001 / Bianco / White



FLAG001 / Giallo / Yellow



FLAR001 / Rosso / Red



FLAV001 / Verde / Green

RUBBER MATS FOR
SAFETY AND FLAIR TRAINING.



FLOM001 / Tappeto gomma per allenamento
FLAIR 80*120*22 mm



FLOG001 / Tappeto gomma per allenamento
FLAIR 100*150*22 mm

BRANDED TOOLS

Vi presentiamo alcuni esempi di personalizzazioni eseguite per famosi brand del beverage internazionale. Una piccola parte del nostro incredibile assortimento di accessori professionali in materiali di alta qualità ad uso alimentare

We present some examples of branded tools made for famous beverage brands. A small part of our incredible range of professional barware made high quality food grade material.

RICHIEDI IL NOSTRO CATALOGO COMPLETO!



SI FIDANO DI NOI



MOLECULAR

I cocktail molecolari vengono creati utilizzando le tecniche della cucina molecolare. I cocktail si destrutturano in forma di sfere, gelatine, caviale e spume in grado di stupire chi è alla ricerca di originalità e gusto.

Molecular cocktails are created using all the techniques of molecular gastronomy. These methods enable the creation of greater intensities and varieties of flavours, flavour combinations and different ways of presenting drinks, for example using gels, powders, foams and spheres.

DESIGNED BY
Bar Progress

XLEC001 / SOY LECITHIN
lecitina di soia E322, 130 gr

XXAN001 / XANTANO
gomma xantana E415, 180 gr

XAGA001 / AGAR
agar-agar E406, 180 gr

XCLO001 / CALCIUM CHLORIDE
cloruro di calcio E509, 250 gr

XCIT001 / TRISODIUM CITRATE
citrato trisodico E331, 250 gr

XALG001 / SODIUM ALGINATE
alginato di sodio E401, 180 gr

XSUC001 / SUCROSE ESTERS
sucroestere di acidi grassi E473, 180 gr



KITM001
SPHERIFICATION
TOOLS KIT
kit strumenti sferificazione:
2 siringhe graduate,
1 set misurini,
1 cucchiaino mixologist



BAR
— IN PROGRESS

Master Class srl - Via dei Salici 17-19
06083 Bastia Umbra (Pg) - Italy
T. +39 075 8012711 - +39 075 9288005
commerciale@barinprogress.com
www.barinprogress.com